

**ASYNCHRONOUS VARIABLE FREQUENCY,
PERMANENT MAGNET VARIABLE FREQUENCY
AIR COMPRESSOR CONTROLLER**

MODLE: MAM-860C

**USER
MANUAL**

Shenzhen Plot Electronic Co., Ltd

Address: 4-5F,5 Bldg,Highstar Industry Park,Gangtou Community,
Bantian,Longgang District,Shenzhen City, China

Telephone: (+86 0755) 83173599 / 83172822 Postal code: 518034

Fax: (+86 0755) 83172966

E-mail: plt@pltsz.com

Web site: www.pltsz.com

VOTE OF THANKS

Thank you for your trustworthy and select of PLOT air compressor controller !

Shenzhen Plot Electronic Co., Ltd specializes on the manufacture and R&D of air compressor controller. We are devoted to win customer trust through our high quality products and service.

We try our best to ensure the completeness and correctness of the manual, but PLOT Company shall reserve the rights for continuous research and improvement on its products and assume no obligation for the modification and improvement on the previously delivered products. The design of products is subject to the change without notice.

Please feel free to contact our after-sale service center if you encounter any problem with our product.

You are always welcome to make suggestions and advices!

NOTICE



Please read all the operation manual before operating the set and keep this manual for further reference.



Installation of MAM—8** compressor controller can be performed only by professional technicians.



Installation position shall be considered carefully in order to ensure good ventilation and reduce electromagnetic interference.



Wiring shall be performed respectively according to regulations for heavy and weak current to reduce electromagnetic interference.



RC snubber must be connected to the two terminals of coil (such as AC contactor ,valve, etc),which are controlled by relay output.



Port connection shall be inspected carefully before power on.



Correct ground connection (the third ground)can help increase product capacity of resisting signal interference.



Set rated current of motor: the max current of motor/1.2.

Features:

- Chinese / English display.
- Asynchronous variable frequency/Permanent magnet variable frequency control.
- Slow stop/Free stop converter control.
- One relay output function set.
- Two digital input function set.
- Two options in block mode, VF-VF block, VF-PF block control(VF: variable frequency; PF: power frequency)
- Two RS-485 ports, one for inverter and the other for block control or external communication
- Integrate PID calculation and control , realize constant pressure supply based on air pressure and inverter operation frequency

Contents

1、 Basic Operation	- 5 -
1、 Button explanation.....	- 5 -
3、 Status Display and Operations	- 6 -
4、 Operating Parameter and Menu	- 7 -
5、 Customer Parameter View and Modification:.....	- 7 -
6、 Customer Parameter Sheet and Function	- 9 -
7、 Factory Parameter View and Modification	- 11 -
8、 Parameter Modification	- 14 -
9、 Operating Authorization and Password	- 15 -
2、 Controller Function and Technical Parameter	- 15 -
3、 Model and Specification	- 17 -
4、 Installation	- 17 -
1、 Mechanical Installation.....	- 17 -
2、 Electrical Wiring Installation	- 19 -
5、 Control Process.....	- 20 -
1、 Single Machine	- 20 -
2、 Net Work.....	- 21 -
3、 Fan Operation	- 21 -
6、 Alarm Function.....	- 21 -
1、 Air Filter Alarm	- 21 -
2、 Oil Filter Alarm	- 21 -
3、 O/A separator Alarm.....	- 21 -
4、 Lubricating Oil Alarm.....	- 21 -
5、 Grease Alarm	- 21 -
6、 Belt Alarm.....	- 21 -
7、 High Discharge Air Temperature Alarm	- 21 -
7、 Controller Protection	- 21 -
1、 Fan Protection.....	- 21 -
2、 Protection of High Discharge Air Temperature	- 22 -
3、 Low Temperature Protection.....	- 22 -
4、 Protection of Air Compressor Non-reversing	- 22 -
5、 Open phase protection	- 22 -
6、 Protection of High Pressure	- 22 -
7、 Protection of Sensor Failure	- 22 -
8、 Troubleshooting.....	- 22 -
1、 This Fault Review.....	- 22 -
2、 Common Failures and Causes.....	- 23 -
9、 Block mode control and net work.....	- 23 -
1、Block mode control.....	- 23 -
2、Net Work.....	- 25 -
10、 Device Explanation.....	- 25 -
11、 Electronical Diagram	- 25 -

1、 Basic Operation

1、 Button explanation

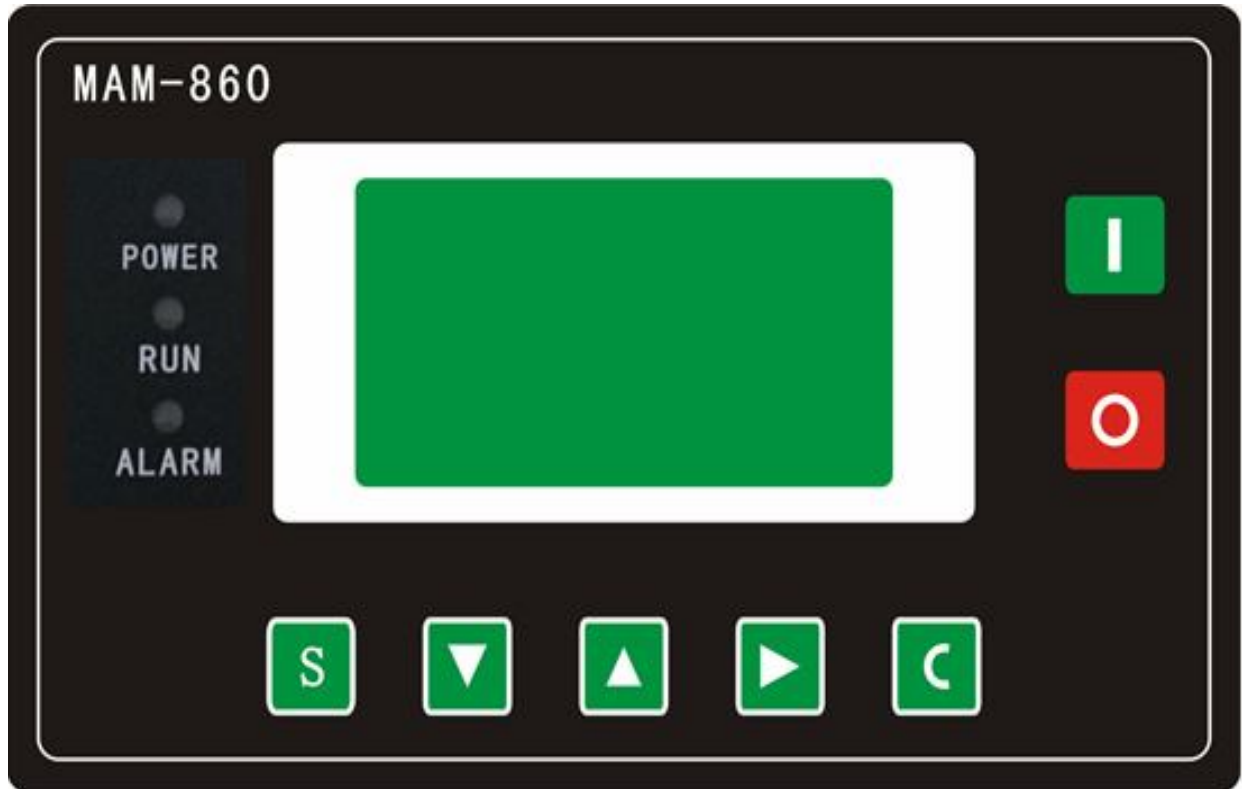





Figure 1.1.1

-  — Start Button:
 - When compressor is at stop status, press this button to start the compressor.
 - When compressor is set as master (No.1) in block mode ,press this button to start the compressor and activate block mode function at the same time.
-  — Stop Button:
 - When the compressor is at running status, press this button to stop the compressor;
 - When compressor is set as master (No.1) in block mode ,press this button to stop compressor and block mode function as well;
 - When compressor is at stop status, long press this button to display software edition.
-  — Set Button /Loading / unloading Button:
 - When the compressor is at running status ,press this button to load, unload ;
 - When the compressor is at setting mode, press this button after modification to confirm and save the modified data.
-  — Move down button / Decreasing button:
 - When viewing the menu, press this button to move downward the cursor.
When modifying data, press this button to decrease the data at current position.



Move up button/Increasing button:

- when viewing the menu, press this button to move upward the cursor ;
When modifying data, press this button to increase the data at current position .



Shift button /Enter button:

- When modifying data, press this button to move to the next data bit;
- When select menu, press this button to switch to submenu. If no submenu available, the controller will shift to data setting mode.



Return button / Reset button:

- When modifying data, press this button to exist data setting mode;
- When viewing the menu, press this button to return to previous menu;
- When the controller is at failure stop status, long press this button to reset.

2、Indicator Instructions

Power: Indicator is on when controller is powered on.

Run: Indicator is on when motor is running.

Alarm: Indicator is on when controller is alarming;

Indicator is on when compressor is failure stop;

Indicator is off after error is cleared and reset.

3、Status Display and Operations

The display screen will show as below after powered on:

WELCOME USING
SCREW
COMPRESSOR

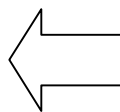

After powered on, show this menu

After 5 seconds, the menu will switch as below:

AIR T: 80°C	0.0Hz
AIR P: 0.53MPA	0RPM
NORMAL STOP	
381.2V	36.9KW

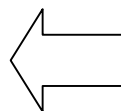

Main menu

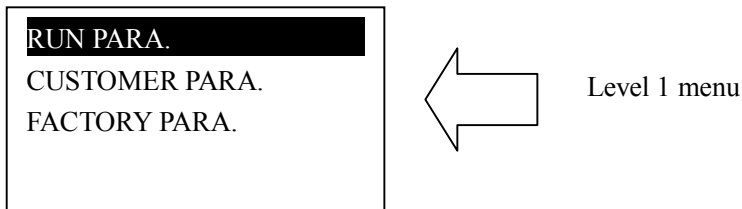

Press “  ” to enter into Selection Menu:



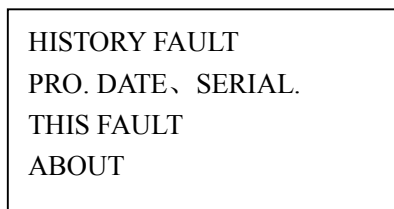
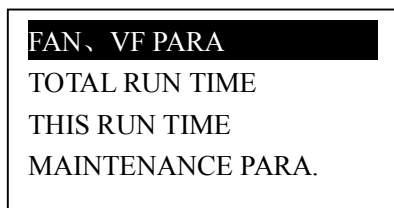

4、 Operating Parameter and Menu

Press “” to move the cursor to “RUN PARAMETER”, then press “” to switch to secondary menu:



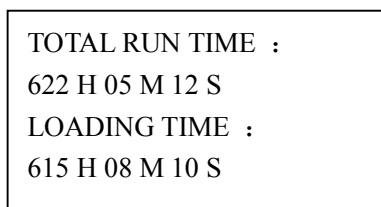

Move the cursor to the corresponding menu item, press “” to check the specific parameter. Such as viewing item TOTAL RUN TIME, move the cursor to item TOTAL RUN TIME, press “” to switch to item TOTAL RUN TIME .



Press “” to return to the previous menu or the main menu. If no operation at the current menu for 120 seconds , controller will automatically return to the main menu and turn off the backlight simultaneously.

5、 Customer Parameter View and Modification:

In first menu, press“” and “” to move the cursor to item CUSTOMER PARA., press “” to switch to the following menu:

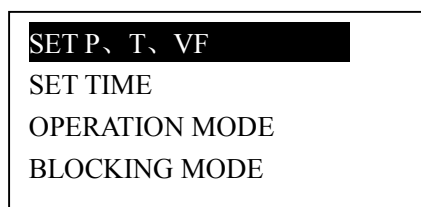

```

CLR LIFE TIME
MAX LIFE TIME
USER CODE: ****
LANGUAGE SEL :EN

```

Move the cursor to item SET P、T、VF, then press “” to switch to the following menu:

```

LOAD P: 00.62 MPa
UNLOAD P: 00.78MPa
VF P: 0070°C
FAN START : 0075°C

```

```

FAN STOP :0070°C
RAT POWER: 022.0KW
RAT SPEED: 1500RPM





```

Move the cursor to item LOAD P, then press “” to switch to the following menu which requires a user password input.

```

ENTER CODE
****

```

In this menu, the first data bit of password started blinking, press “” or “” to modify the the first bit of password, Press “”, move the cursor to the next data bit,modify the second data of password. In accordance with the above , modify the third and fourth data of password in sequence. Press“” to confirm the input data and the menu will switch to the following menu after verification:





```

LOAD P: 00.62 MPa *
UNLOAD P: 00.78MPa
VF P: 00.70MPa
FAN START: 0080°C

```

The upper right corner with "*" indicate the system verification of the password

In the menu above , press “” , the first data of LOAD P starts to blink, user can

press “” or “” to modify the present data in accordance with the above method .Press “” to move to next data bit and modify the target data in sequence. When finished, press “” to confirm and save the data. The controller prompt sends out a short voice to tip the completion of parameter set.

6、Customer Parameter Sheet and Function

First menu	Second menu	Preset Data	Function
SET P、T、VF	LOAD P.	00.6MPa	1,In AUTO LOADING status , compressor will load if pressure is below this set data 2,In STANDBY mode, compressor will start if the pressure is below this set data
	UNLOAD P.	00.80Mpa	1.Compressor will unload automatically if air pressure is above this set data 2.This data should be set above LOAD P ,also should be set below ULD LIM P
	VF P	00.70MPa	Set AIR P for VF compressor to keep running stable, when pressure is fluctuated around this data, controller will adjust operation frequency of inverter to control the pressure close to this data
	FAN START	0080℃	Fan will start if AIR T is above this set data
	FAN STOP	0070℃	Fan will stop if AIR T is below this set data
	RAT POWER	022.0KW	Set RATED POWER in order to calculate actual power
	RAT SPEED	2600RPM	Set RATED SPEED at 50HZ in order to calculate the actual speed in variable frequency
SET TIME	FAN DELAY	0010S	Set the fan start time, record time when fan is activated, controller will not start overload protection during this time to avoid impulse starting current stopping the fan.
	LOAD DELAY	0005S	Unloading in this set time after enter delta running
	EMPTY DELAY	0010S	When unloading continuously, compressor will automatically stop and enter to standby status if over this set time
	STOP DELAY	0003S	For NORMAL STOP operation, compressor will stop after it continuously unloading over this set time
	START DELAY	0005S	Machine can be restarted only over this set time at any case(after NORMAL STOP, STANDBY or FAILURE STOP)
	VSD UP SPEED	0010	Restrict PID calculations in case the frequency increasing too fast which cause motor speeding up too fast
	VSD DN SPEED	0010	Restrict PID calculations in case the frequency decreasing too fast which cause motor slowing down too fast

OPERATION MODE	ON/OFF MODE	LOCAL/REMOTE	<p>1. When set as LOCAL ,only the button on the controller can turn on and turn off the machine.</p> <p>2. When set as REMOTE mode, both the button on the controller and the remote control button can turn on and off the machine;</p>
	LOAD MODE	AUTO/MANU	<p>1. When set as the MANU : only when the pressure is above UNLOAD P, compressor will unload automatically .For any other case, the Load/Unload function can only be executed by pressing load/unload key.</p> <p>2. When set as AUTO ,the loading/ unloading function can be executed by the fluctuation of AIR P automatically</p>
	COM MODE	COMP./BAN/ BLOCK	<p>1. When set as BAN, the communication function is invalid.</p> <p>2. When set as COMP, compressor can communicate with computer or DCS as slave according to MODBUS-RTU.</p> <p>3. When set as BLOCK, compressor can work in net</p>
	COM ADD	0016	Set the communication ADD in block mode or when communicate with monitoring center. This ADD is unique for every controller in net
BLOCK MODE	BLOCK STA	MASTER/SLAVE	<p>1. When service as master in BLOCK. Master controls slave, the COM ADD should be set to No.1</p> <p>2. When service as slave in BLOCK, slave is controlled by master</p>
	BLK MODE	VF—PF/VF—VF	<p>VF—PF:VF compressor and PF compressor work in block mode</p> <p>VF—VF:VF compressor and VF compressor work in block mode</p>
	BLK NUM	0000	Number of air compressors in block net
	TURN TIME	9999 Hours	When master pressure is between BLOCK LOAD P and BLOCK UNLOAD P, master determine slave work alternatively over this set time .
	BLK MAX	00.75MPa	In BLOCK mode, one compressor will stop or unload when pressure is above this set data
	BLK MIN	00.65MPa	In BLOCK, one compressor will start or load when pressure is below this set data
	BLOCK DELAY	0000S	In BLOCK mode, when master sends two commands continuously, second command signal delays for this set data,
CLR LIFE TIME	OIL RESET	0000H	Record oil filter total run time. If changing new oil filter, the parameter should be reset by manual operation.
	O/A RESET	0000H	Record O/A separator total run time. If changing new O/A separator, the parameter should be reset by manual operation
	AIR RESET	0000H	Record air filter total run time. If changing new air filter, the parameter should be reset by manual operation

	LUBE RESET	0000H	Record lubricating oil total run time. If changing new lubricating oil, the parameter should be reset by manual operation
	GREASE RST	0000H	Record grease total run time. If changing new grease, the parameter should be reset by manual operation
	BELT RESET	0000H	Record belt total run time. If changing new belt, the parameter should be reset by manual operation
MAX LIFE TIME PRESET	OIL FILTER	0000H	1,Alarm prompts when oil filter total run time is over the parameter set. 2,Set this data to "0" to invalidate the oil filter alarm function
	O-A SEPAR	0000H	1,Alarm prompts when O/A separator total run time is over the set data. 2,Set this data to "0" to invalidate the O/A separator alarm function
	AIR FILTER	0000H	1,Alarm prompts when air filter total run time is over the parameter set. 2,Set this data to "0" to invalidate the alarm function of air filter
	LUBE	0000H	1,Alarm prompts when lubricate total run time is over the parameter set. 2Set this data to "0" to invalidate the alarm of lube.
	GREASE	0000H	1,Alarm prompts when grease total run time is over the parameter set. 2Set this data to "0" to invalidate the alarm of grease.
	BELT	0000H	1,Alarm prompts when belt total run time is over the parameter set. 2Set this data to "0" to invalidate the alarm of belt.
USER CODE		****	It is allowed to modify the USER CODE after authorization
LANGUAGE SEL	CN/EN	EN	Chinese display when set to CN English display when set to EN

7、 Factory Parameter View and Modification

The view and modification of factory parameter requires a factory password, The modification step is same as customer parameter modification. Main function is as below:

PARAMETER		Initial Data	Function
BASIC PARA	FAN CUR	Maximum fan overload data/1.2	When the current of fan is more than 1.2 times and less than 4 times of the set data , the unit will shut down according to overload feature.
	ALARM T.	105℃	Alarm prompt when actual AIR T is over the parameter set
	STOP T.	110℃	Alarm and stop when actual AIR T is over the parameter set
	RUN TIME	000010Hours	Modify the TOTAL RUN TIME
	LOAD TIME	000009Hours	Modify the LOAD TIME

	MAX U.L.	0.80MPa	The UNLOAD P in CUSTOMER PARA must be set no higher than this set data.
	STOP P.	1.00MPa	Alarm and stop when actual AIR P is above this set data
	FAULT RESET	0000	Input the password and press “set“ button to clear all the history failures record.
	SERIAL	*****	The range of every data bit is 16 data: 0-9,A,B,C,D,E,F
	DATE	****_**_**	Production date
	FREQ.SEL	60HZ/50HZ	Select compressor power frequency to test fan current .Use super password to revise this data
	PHASE PRO	ON/OFF	ON:select phase sequence protection function OFF:Invalid phase sequence protection function. Use super password to revise this data
	MAX TIME	0000H	1,Alarm and stop when the compressor is in a stop status and the TOTAL RUN TIME is over this MAX TIME set. 2,Set the data to ‘0000’, to invalid the function.
	MAX ALARM	0010H	When controller detect oil filter, O/A separator. lubricating oil ,grease and belt running over the max time and alarm over the data set ,compressor will reports MAX ALARM and stop
	SPARE	0001	Standby
	LOW T PRO	-048℃	1,In stop mode, air compressor is not allowed to start when air temperature is lower than this set data 2,Two minutes after turn on, when the air temperature is below this data, compressor will stop and indicate LOW T
	CODE2	****	Use this code to change all CUSTOMER PARA and part of FACTORY PARA (except TOTAL RUN TIME,LOADING TIME,TIME LIMIT , MAX ALARM , FREQ SEL,PHASE PRO, CODE2,TIME CODE)
	TIME CODE	****	Use this code to change all CUSTOMER CODE, TOTAL RUN TIME ,LOADING TIME ,TIME LIMIT,MAX ALARM ,FREQ SEL,PHASE PRO
	COM SET PARA	ON/OFF	1,When set as ON,DCS can set data through MODBUS protocol; 2,When set as OFF,DCS cannot set data through MODBUS protocol 3, DCS can set data only when compressor is at stop status .
VF PARA	INT SCAL	00.20 MPa	(PID TARGET PRESS set value - INTEGRAL SCALE)< detected AIR P < (PID TARGET PRESS set value + INTEGRAL SCALE) INTEGRAL GAIN works
	INT SCAL	0020	When detected AIR P< (PID TARGET PRESS set value-INTEGRAL SCALE) or

			Detected AIR P> (PID TARGET PRESS set value+INTEGRAL SCALE) Integral calculation based on this data
	PROP GAIN	0010	Track speed of PID TARGET PRESS set value , the bigger the data, the faster the track; the smaller the data the slower the track
	INT. GAIN	0012	Track the speed of PID TARGET PRESS set value and STEADY STATE ERROR, the bigger the data ,the faster the track and the smaller the STEADY-STATE ERRORS ;the smaller the data ,the slower the track and the bigger the STEADY-STATE ERRORS
	DIFF GAIN	0000	Track the hysteresis system(such as temperature) not use very often and normally set as “0000”
	MAX FREQ	050.0Hz	The max frequency in LOADING MODE
	MIN FREQ	030.0Hz	The min frequency in LOADING MODE
	U.L. FREQ	010.0Hz	Permitted operating frequency in UNLOAD MODE
	DIFF.P	00.72MPa	When use compressor to adjust speed and balance pressure and the AIR P is detected higher than the set DIFF P,the DIFF F works
	DIFF.F	005.0Hz	When use compressor to adjust speed and balance pressure and the AIR P is detected higher than the set DIFF P ,sent the data (CONTROL FREQUENCY based on the PID OPERATION FREQUENCY- SET FREQUENCY) to inverter to avoid AIR P over PID TARGET PRESS too far which may cause the compressor loading and unloading frequently.
	VF 0		Set the inverter model, controller read the operation parameter based on user model
	STOP MODE	SLOW-D/FREE-S	When STOP MODE set as FREE-S in FACTORY PARA :compressor receive stop command,16 terminal opens and valve is de-energized ,13 and 14 terminals keep closed until 1 S before STOP DELAY finish .When STOP MODE set as SLOW-D in FACTORY PARA :compressor receive stop command,13 and 14 terminals open and 16 terminal opens, valve is de-energized .The compressor will stop if SLOW D is set to zero
	PID	000.5 S	
HARDWARE FUNCTION SET	3 FUNC	EMERG.、 NO FUNC、 REMOTE OFF、 REMOTE ON、 ON/OFF、 REMOTE(INCHING) 、 PRE-A(NC)、 ALARM(NO)	3,4 terminal digital input function set
	4 FUNC		

		FAULT(NC), FAULT(NO) AIR FIL(NC), AIR FIL (NO) O-A SEP,(NC) O-A SEP(NO) OIL FIL,(NC) OIL FIL(NO) NO:NORMAL OPEN NC:NORMAL CLOSE	
	17 FUNC	RUN /REMOTE/ALARM	17 terminal can be selected as RUN INDICATOR,REMOTE INDICATOR,ALARM INDICATOR

8、Parameter Modification

You can set relative data of controller in “Calibrate parameter”. It is not allowed to view and modify without manufacturers authorization. User can input calibrate password in factory menu to enter the parameter modification menu

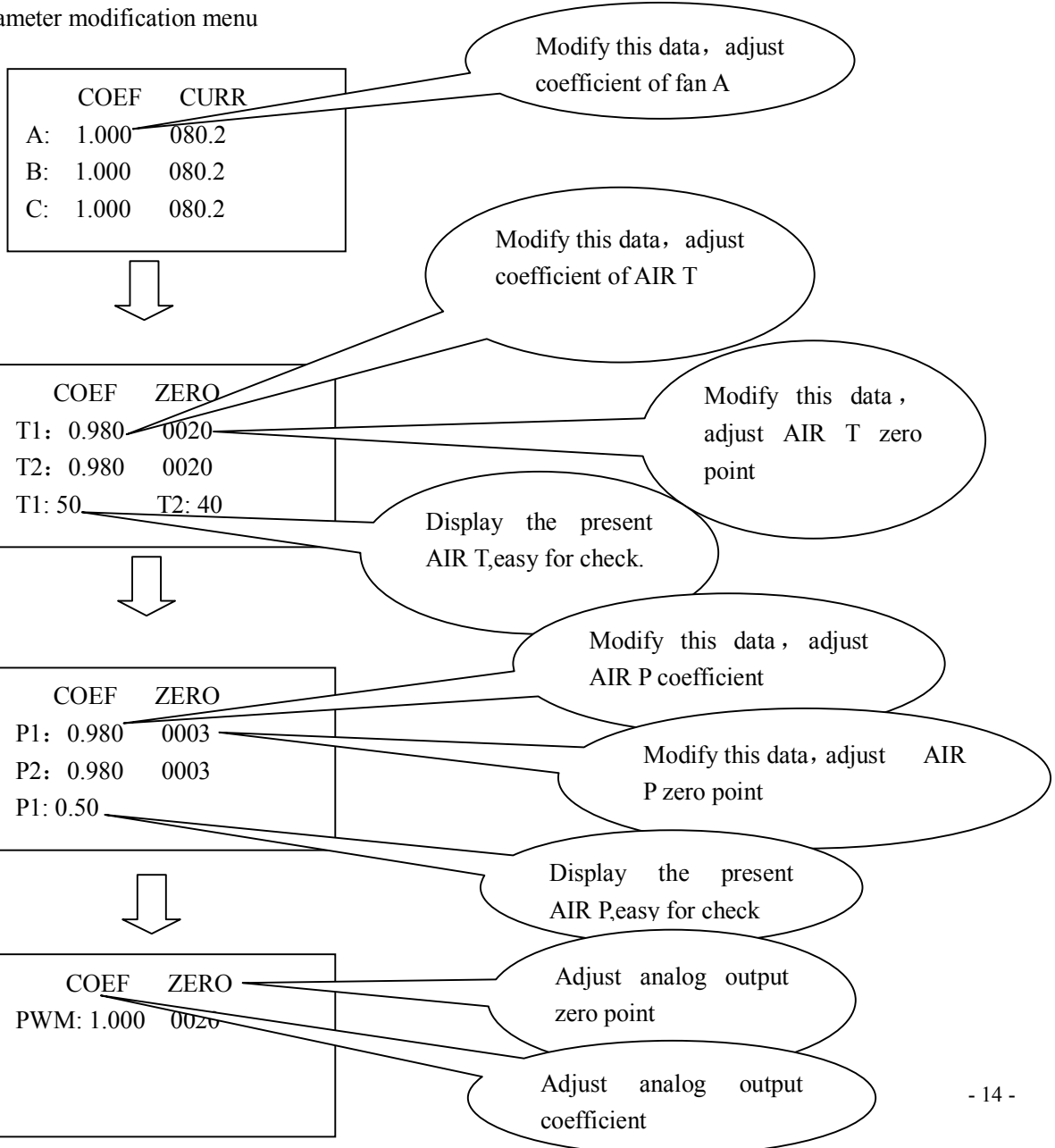

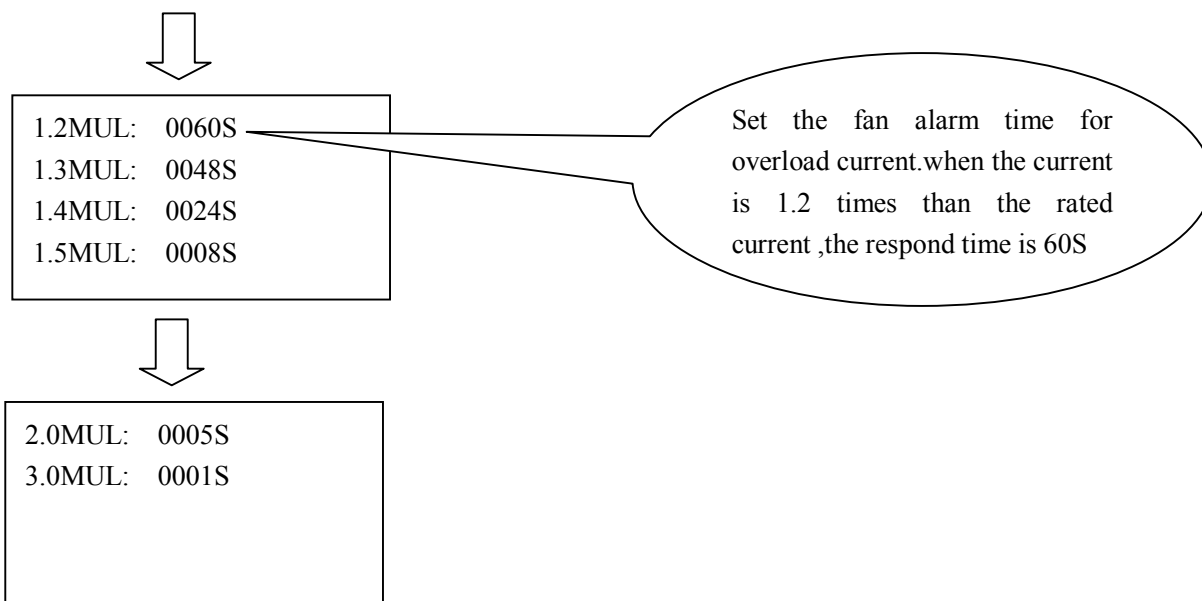

In CALBR PARA menu, user can adjust parameter such as FAN CURRRNT & COEF, TEMP COEF & ZERO POINT, PRESSURE COEF & ZERO POINT, PWM COEF & ZERO POINT and FAN OVERLOAD.

9、 Operating Authorization and Password

Controller provides multiple passwords and access management. According to different levels of passwords, controller provides different levels of operating authorization, details as following:

1. USER CODE: factory set: _____
Permissions: Allows to modify all CUSTOMER PRAMETER.
2. FACTORY CODE: fixed: _____
Permissions: Allows users to modify all CUSTOMER PARA and FACTORY PARA.
3. CODE2: set in FACTORY PARA, FACTORY CODE is required for reset: _____
Permissions: Allows users to modify all USER PARA, all FACTORY PARA except TOTAL RUN TIME, LOADING TIME, MAX LIFE TIME, MAX ALARM, FREQ, PHASE PRO, CODE2, TIME CODE.
4. TIME CODE: set in FACTORY PARA, FACTORY CODE is required for reset: _____
Permissions: Allows users to modify all USER PARA; part of FACTORY PARA such as TOTAL RUN TIME, LOADING TIME, MAX LIFE TIME, MAX ALARM, FREQ, PHASE PRO
5. CALIBRATE CODE: fixed: _____
Permissions: Calibrate relative coefficient of fan current

2、 Controller Function and Technical Parameter

- 1、 Digital input&output: 3 points of Digital input ;5 points of digital relay output ;
- 2、 Analog input: 1 point of Pt100 temperature input ; 1 point of 4~20mA pressure signal input; 1 group of three phases current inputs(CT provided); 1 point of 4~20mA analog current output

- 3、 Input voltage of phases:380V/220V;
- 4、 Controller working power supply:AC16-28V、 50/60HZ、 0.3A、 6VA(12 VA is recommended)
- 5、 Measurement :
 - ①、 AIR T:-20~150℃; Accuracy:±1℃.
 - ②、 Run time: 0~999999 hours.
 - ③、 Current:0~999.9A.
 - ④、 Pressure: 0~1.60MPa. Accuracy: ±0.01Mpa.
- 6、 Phase-sequence protection: When compressor is at stop mode and detects wrong phase, respond time≤2s (optional);
- 7、 Open phase protection: When compressor is at stop mode and detects open phase ,respond time≤2s
- 8、 Motor protection : This controller has overload protection for fan. Show as below:

Iactual/Iset						
Time parameter	≥1.2	≥1.3	≥1.5	≥1.6	≥2.0	≥3.0
Response time (S)	60	48	24	8	5	1

Table 2.1.1 curve table for protection of motor

- 9、 Temperature protection: when actual temperature detected is higher than temperature set; response time≤2s;
 When the temperature detected is lower than the LOW T PRO, the compressor is not allowed to turn on;
 Two minutes after controller start and detection of low temperature, controller will report LOW T and stop
- 10、 Contact capacity of output relay: 250V,5A; Contact endurance :500000 times
- 11、 Current error is less than 1.0%.
- 12、 RS485 communication function
 - 1,Block mode control
 - 2, Communicate with-external devices as slave through MODBUS RTU, baud rate 9600BPS,1start bit,8 data bits,1 stop bit and even parity
- 13.Remote control compressor: When set as REMOTE, user can remotely control the compressor.

3、 Model and Specification

1、 Model Description

MAM 860C (B) (T)

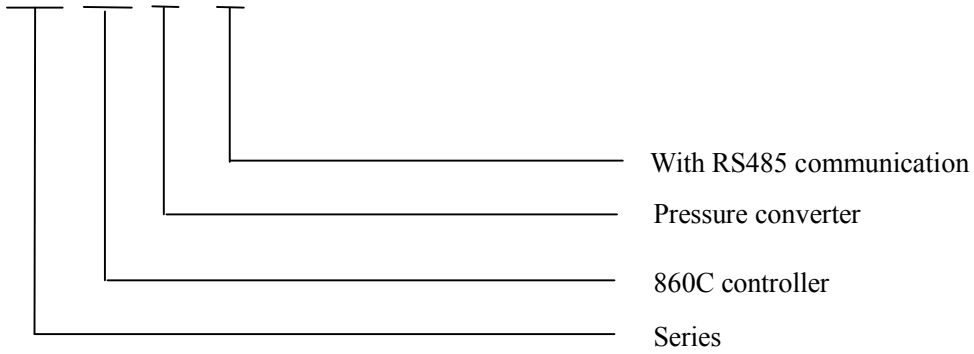

4、 Installation

1、 Mechanical Installation

①、 Current transformer installation

The CT shall be installed at a place where the current of motor cable can be measured, thus, controller can be set according to instructions on motor nameplate, the detailed dimensions is shown as below:

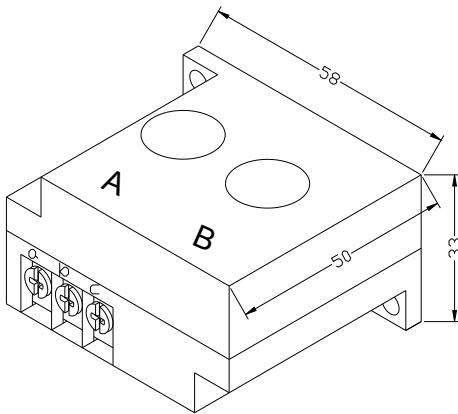

Picture4.1.1、 Structural dimensions of CT2 (ϕ 10 through hole)

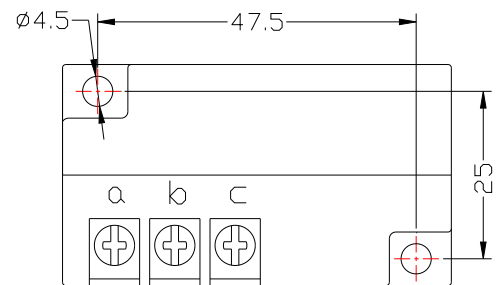

Picture 4.1.2、 CT2 Installation dimensions

②、Controller installation

The controller is installed as plate. Room should be left around controller for wiring. The specific dimension is shown as below:

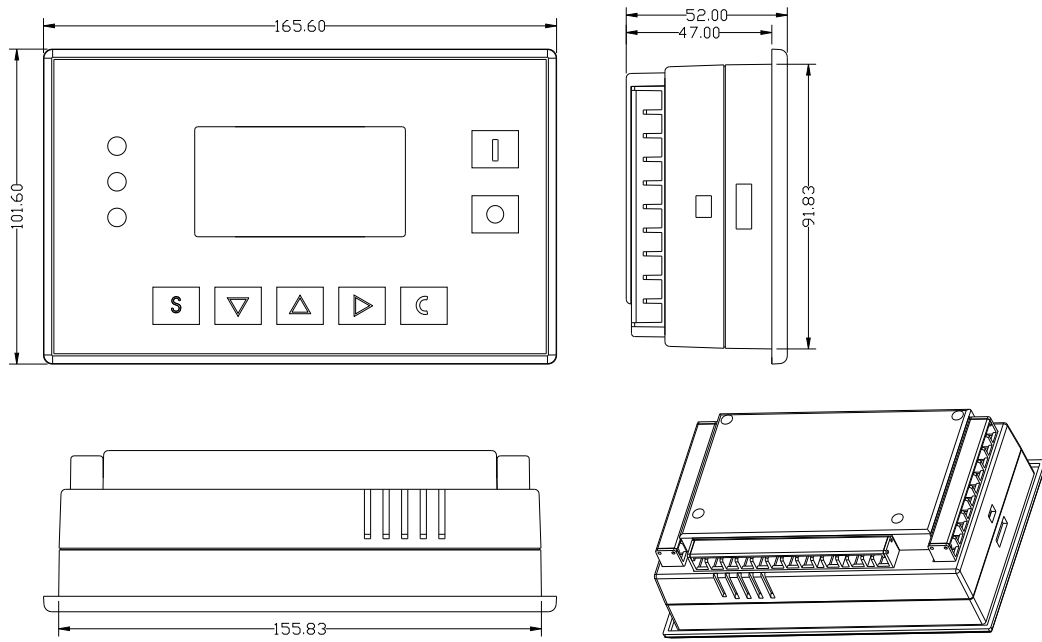

Figure 4.1.3 Controller structure dimension

MAM860C HOLE SIZE

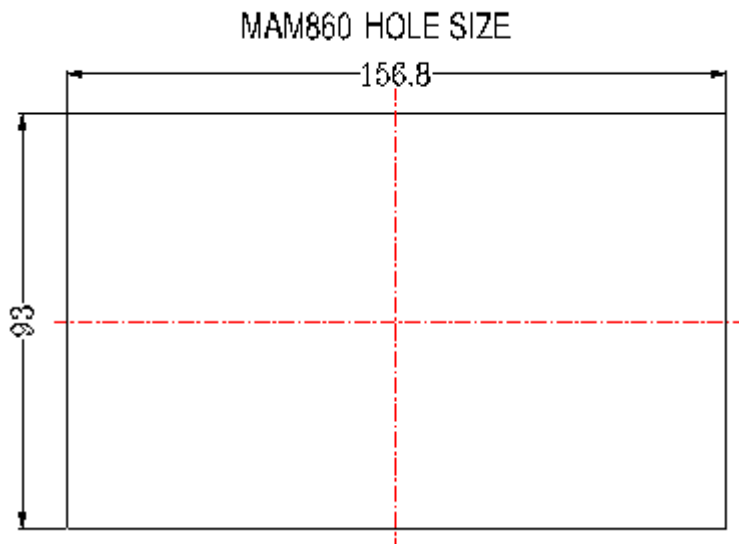

Figure 4.1.4 Hole size

2、Electrical Wiring Installation

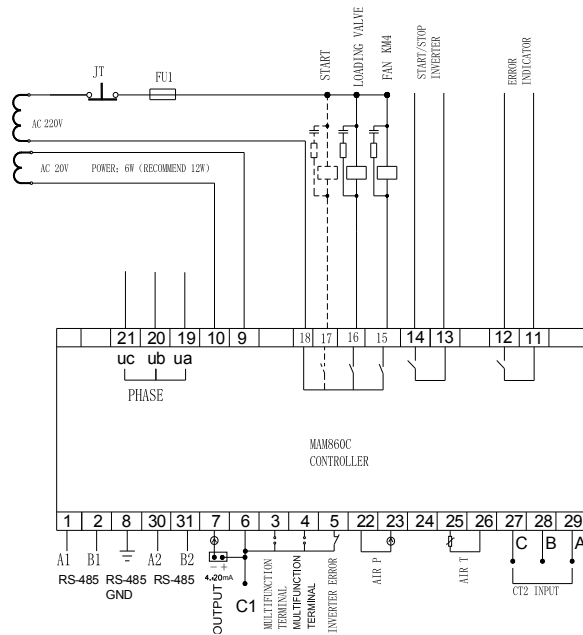



Figure 4.2.1 Terminal arrangement diagram

<u>1,2</u>	RS485 port , communicate with compressor or DCS center in block mode	<u>3</u>	Multifunction digital input terminal	<u>4</u>	Multifunction digital input terminal
<u>5</u>	Inverter failure detect terminal	<u>6</u>	Digital input common terminal and 4~20mA output terminal;	<u>7</u>	4~20mA input terminal;
<u>8</u>	485 Communication ground	<u>9, 10</u>	Terminal for the AC20V power source	<u>11, 12</u>	Error signal
<u>13, 14</u>	Start /stop inverter	<u>15</u>	Valve for fan control	<u>16</u>	Loading valve control
<u>17</u>	Multifunctional output relay terminal	<u>18</u>	output relay common terminal	<u>19, 20, 21</u>	Input terminal to detect the phase sequence and voltage
<u>22, 23</u>	Pressure sensor terminal	<u>24</u>	N/A	<u>25, 26</u>	Temperature sensor terminal
<u>27, 28, 29</u>	Fan current transformer terminal	<u>30</u>	Other 485 port, read inverter data		

Note :Electromagnetism coil shall be connected nearest with RC snubber during wiring

5、 Control Process

1、 Single Machine

①. Press “” for starting: (VF start)

The air compressor can not be started by pressing “” until 5 seconds self-test finished. The start course of compressor is as followed: 13 and 14 terminals closed, inverter receives starting signal ,7 and 6 terminals output 4~20mA current to inverter to control operation frequency, motor starts running.

②. Automatic operation control:

A,Controller starts PID calculation based on AIR P detected and inverter operation pressure, output 4~20mA current to inverter to adjust motor speed, the fluctuation of motor speed influence the fluctuation of air supply to realize constant pressure in this closed-loop control system.

B,If AIR P is detected higher than set UNLOAD P,16 terminal opens, loading valve is de-energized, and air compressor is unloading, and also EMPTY DELAY starts record time, If unloading time exceed EMPTY DELAY set, compressor will enter standby mode; If compressor loading within EMPTY DELAY set(when AIR P is below LOAD P or receives loading command),compressor will reset EMPTY DELAY automatically.

C,In standby mode, controller start automatically if detected AIR P is below LOAD P set value

D,In unloading status, controller output unload frequency directly; In load status, frequency is fluctuated between MAX FREQ and MIN FREQ

③. Manual load/unload under automatic status

A:When AIR P is between LOAD P and UNLOAD P, press “load/ unload” , controller swift the current status once .

B,When AIR P is above the UNLOAD P, controller will unload automatically ,the load/unload button is invalid

C,When AIR P is below the LOAD P, controller will load automatically ,the load/unload button is invalid

④. Normal stop:

A,FREE-S:After controller receiving stop command,16 terminal opens and valve is de-energized,13 and 14 terminals keep closed till 1 S before stop delay.

B,SLOW-D:After controller receiving stop command,13,14 and16 terminals open, valve is de-energized.

⑤. Control of frequent starting

After press “” to stop the air compressor, air compressor can not be started immediately after normal stop or FAIL TO STOP, and it can be started again after START DELAY.

⑥.Remote Automatic Control (On-off Mode: Remote; Load Mode: Auto)

In this mode, compressor can be turn on or off by remote control .

⑦.On-site Control (On-off Mode: Local, Load Mode: Manual)

A,Manual control is the same as automatic control, but device is in status of unloading after finish starting up.

B>Loading is carried out by pressing “load/unload” ; When AIR P is higher than UNLOAD P, the device will unload automatically.

C, No press on “load/ unload” , the device will unload until EMPTY STOP.

D, In load status, press “load/unload” to unload.

2、 Net Work

- ①. Controller works as slave when COM MODE is set as COMP, and communicates with DCS through MODBUS.
- ②. Controller and other controller can work in block mode when COM MODE is set as BLOCK, but the master only can service as 1# compressor.

3、 Fan Operation

When AIR T is higher than FAN START , fan starts; when AIR T is lower than FAN STOP , fan stops .

6、 Alarm Function

1、 Air Filter Alarm

The monitor displays AIR LIFE END when the running time of the air filter exhausts.

2、 Oil Filter Alarm

The text displays OIL LIFE END when running time of the oil filter exhausts.

3、 O/A separator Alarm

The text displays O/A LIFE END when running time of the O/A separator exhausts.

4、 Lubricating Oil Alarm

The text displays LUBE LIFE END when running time of the lubricating oil exhausts.

5、 Grease Alarm

The text displays GREASE LIFE END when running time of the grease exhausts.

6、 Belt Alarm

The text displays BELT LIFE END when running time of the belt exhausts.

7、 High Discharge Air Temperature Alarm

The text displays AIR T HIGH when controller detects the AIR T higher than PRE-A T set data in FACTORY PARA.

7、 Controller Protection

1、 Fan Protection

MAM-860C air compressor controller provides overload protection for fan

2、 Protection of High Air Temperature

When AIR T is above the high limit of PRE-A T , the controller will alarm and stop and This fault displays AIR T HIGH .

3、 Low Temperature Protection

When AIR T is below LOW T PRO in manufacturing parameter. THIS FAULT displays AIR T LOW, two minutes after compressor turns on, the controller will alarm and stop.

4、 Protection of Air Compressor Non-reversing

When compressor is at stop mode and three-phases sequence is not in order. THIS FAULT displays PHASE REVERSAL, and the controller cannot start the motor. Change the position of any arbitrary two-phase power lines and check the rotation of motor.

5、 Open phase protection

When compressor is at stop mode, if phase open is detected. THIS FUALT will display PHASE REVERSAL and compressor is not allowed to start. Check the three phase power.

6、 Protection of High P

When the AIR P is above the MAX LIM P, the controller will ALARM AND STOP .THIS FAULT displays HIGH P.



7、 Protection of Sensor Failure

When pressure sensor or temperature sensor is disconnected, the controller will alarm and stop. THIS FAULT displays **SENSOR FAULT.

8、 Troubleshooting

1、 This Fault Review

Failure stop caused by the external parts of controllers may be removed by checking THIS FAULT or HISTORY FAULT , method is shown as below:

Press “”to move the cursor to RUN PARA menu, then press “” , the secondary menu would be prompted out:

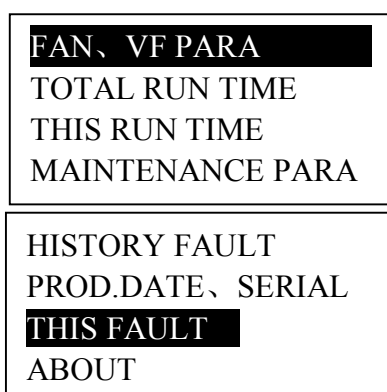

Move cursor to THIS FAULT press “” to switch to the following error menu:

<p>STOP:T SENSOR FAULT 0170°C</p>

User can reset the error according to the following information

2、 Common Failures and Causes

Failure	Reason	Solution
AIR T HIGH	Bad vent condition, Oil shortage etc.	Check the vent condition and lubricant amount etc.
T SENSOR FAILURE	Cable off or PT100 failure	Check the wiring and PT100
AIR P HIGH	Pressure too high or the pressure sensor failure	Check the pressure and the pressure converter
P SENSOR FAILURE	Cable off, Sensor failure or the cable connect reversed	Check the wiring and pressure converter
PHASE REVERSAL	Reversed phase sequence or open phase	Check the wiring

9、 Block mode control and net work

1. Block mode control

①、 Block control explanation

MAM860C controller can work in block mode with MAM serials compressor (with communication function).16 pcs compressors can work together in a net at most. Block mode can be set as VF -VF or VF-PV .The cable connection for block mode control is as below...1,2 terminals (RS485 terminal) are used for block mode.

In block mode menu, set as VF-VF, master choose compressor to work according to the TOTAL RUN TIME, compressor with short run time is chosen to start and compressor with long run time is chosen to stop with priority.

In block mode menu, set as VF-PF, master operation first , other compressors work according to the TOTAL RUN TIME, compressor with short run time is chosen to start and compressor with long run time is chosen to stop with priority.

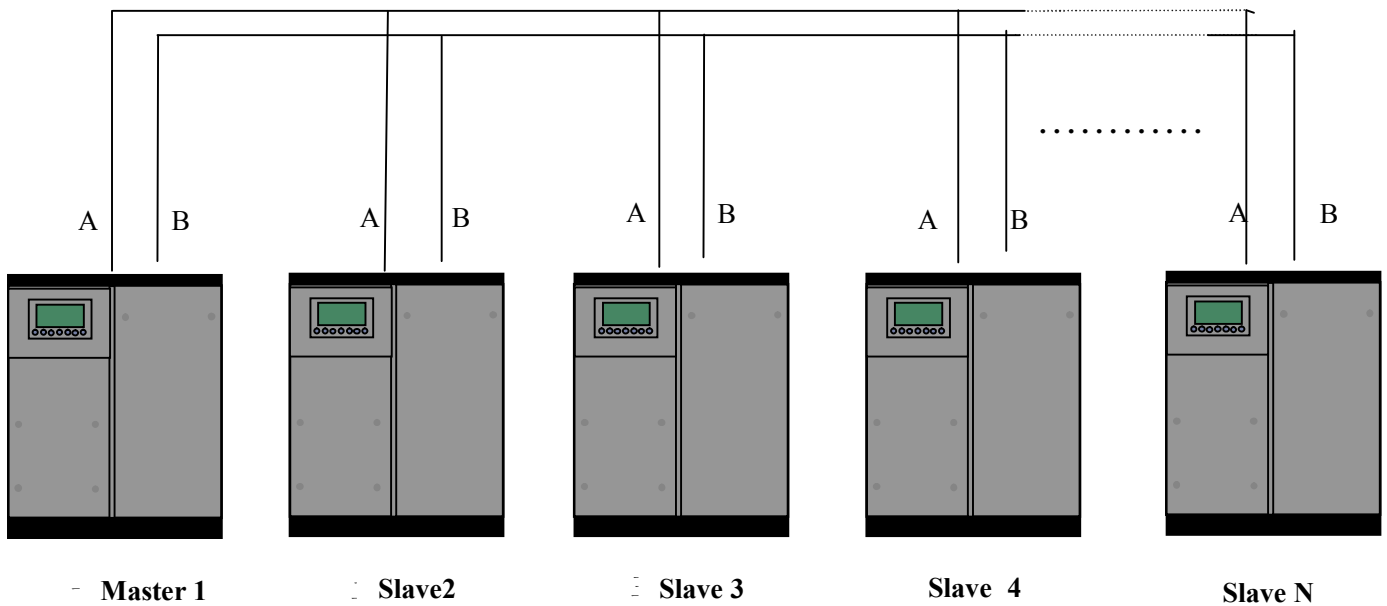



Picture 9.1.1

Compressor with internet COM ADD 0001 is master, others are slave. Any one MAM serials compressor can be set as master or slave.

②、Block mode setting

1.Set as master:

In main menu, press “” to enter menu selection and choose CUSTOMER PARA ,press “” to swift to the menu below:

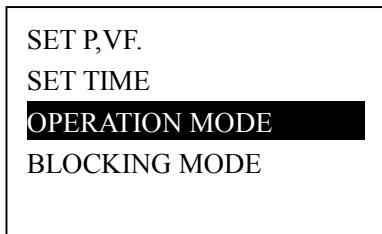

Move the cursor to “OPERATION MODE ” press “” ,swift to the menu below.

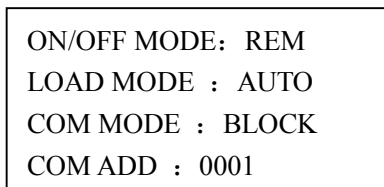

Set COM MODE as BLOCK,COM ADD as 0001,return to the previous menu ,move the cursor to BLOCKING MODE press “” and swift to the menu below

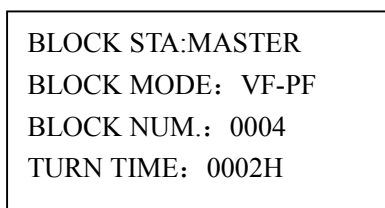

BLK MAX: 00.78MPa
 BLK MIN: 00.62MPa
 BLK DELAY: 0020s

According to user requirement, set BLOCK STA as MASTER, set TURN TIME,BLOCK NUM,BLK MIN,BLK MAX,BLK DELAY accordingly .After set ,controller needs to be powered off and restart to save setting.

2.Set as slave

When MAM860C controller serves as slave ,only need set COM MODE as BLOCK ,COM CODE can be set from2-16 according to the quantity of compressors, and mark with sequence .BLOCK STA set as SLAVE.

③、 Start ,stop block control:

Make sure block cables connect correctly, and the parameter of compressor in block mode set correct. Activate master, master control the compressor in net automatically according to the AIR P detected . When manually stop the master ,block control stops at the same time, thus, master will no longer send command to compressor in net .

2.Net Work

MAM860C controller supports MODBUS RTU protocol and can serve as slave when connect with other equipment and supports 03、 06、 16 MODBUS command. Communication baud rate:9600BPS,1 start bit, 8 data bits, 1 stop bits and even parity. For MODBUS register address ,please see MODBUS communication manual.

10、 Device Explanation

In Operation Para, select item “ABOUT”, press ”, the menu will swift as below:

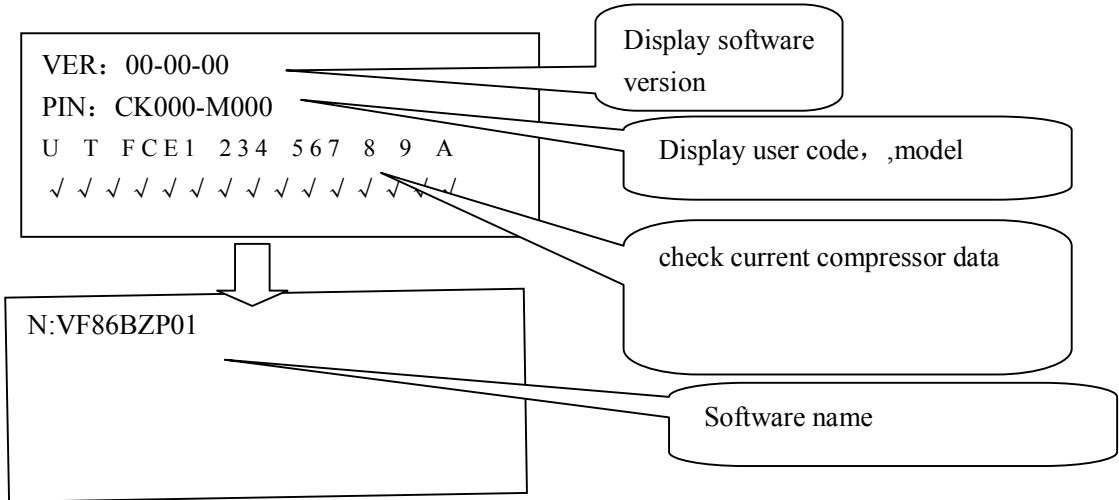

11、Schematic Diagram

